

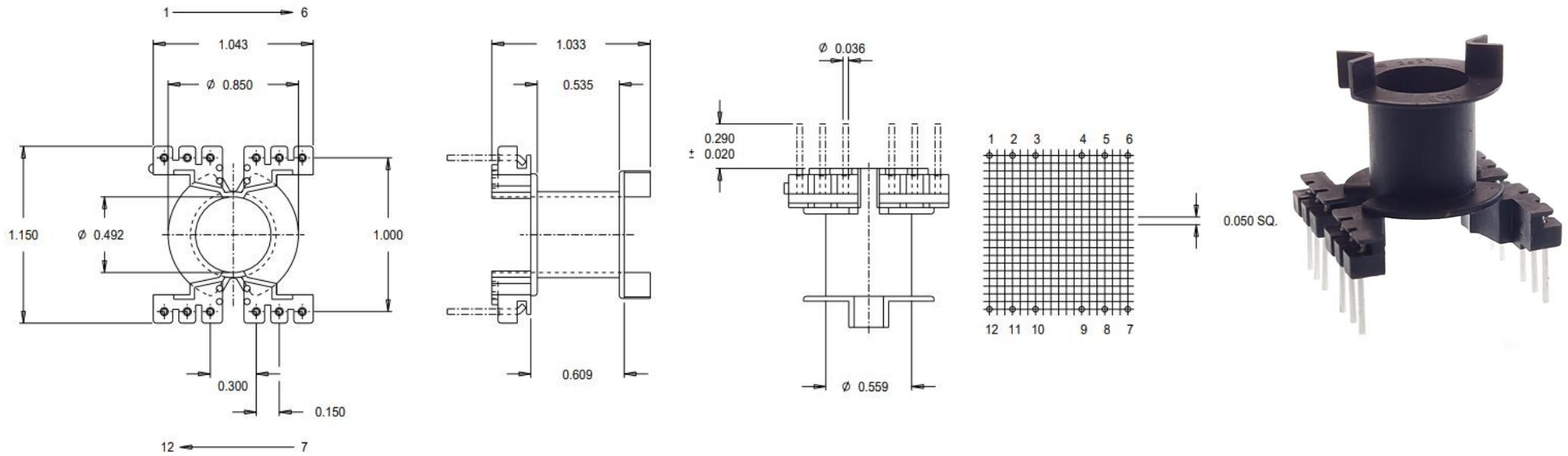

PQ0040



Part Number PQ0040	Part Weight (g) 4.6	Carton Quantity 850	Pinning Configuration TPB-RD-090 1:2:3:4:5:6:7:8:9:10:11:12:
Order Code PQ0040FR3BLK0001	Material Rynite FR530L	Carton Size (mm) 465x315x260	Pin Lenth (INCHES) (from standoff) 0.29
Part Description Bobbin PQ2625 V 12P 1S UL94V0	Material Datasheets	Related Items n/a	Terminal Pin Material Phosphor Bronze
Product Range PQ Range	UL Rating UL94V0	3D CAD Image	Compliance information

MILES - PLATTS

+44 (0)116 264 3850

milesplatts.co.uk

enquiries@milesplatts.co.uk